

Dear Bookseller,

You are about to embark on an amazing adventure into the imagination. All you need to take you there is a cardboard box....

Written as a celebration of every child's creative spirit, **NOT A BOX**, Antoinette Portis's debut picture book, captures the wonder of looking at the ordinary and seeing the extraordinary.

Let your customers' imaginations run wild by hosting your very own B.Y.O.B. event (that's "Bring Your Own Box," of course). Encourage kids to bring a plain cardboard box to your store to decorate and transform. Just like the little bunny in **NOT A BOX**, they will discover how the simplest of things can be the most inspiring.

Inside the pages of this event kit are ideas and activities for hosting your B.Y.O.B. event. Plan your event to promote **NOT A BOX**—and the creativity waiting to be unleashed in every child.

Sincerely,
The HarperCollinsChildren'sBooks
Marketing Department

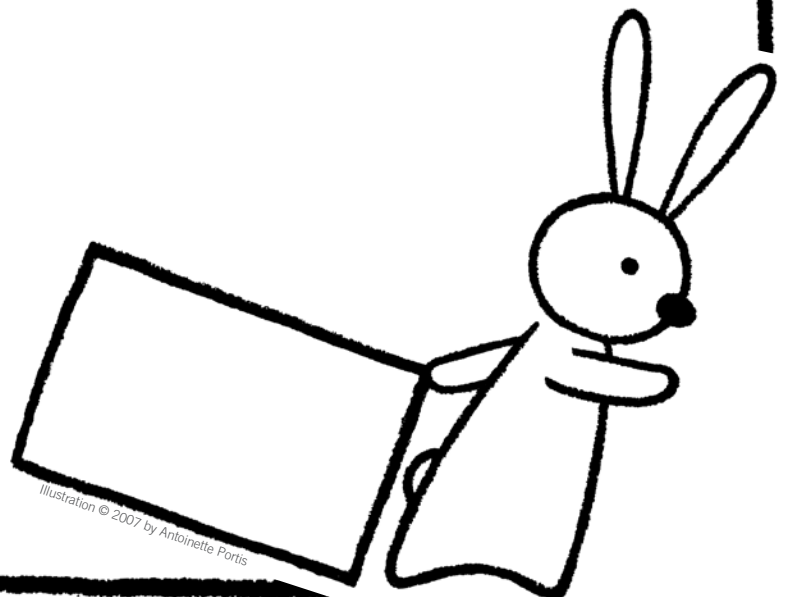
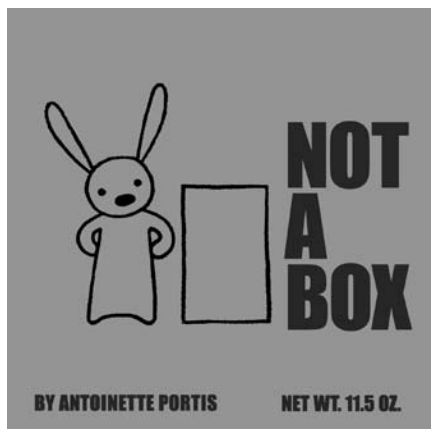

Gather the Boxes!

Your customers will want to know you're having a creative, fun in-store event. And you'll want to let them know to bring their own box. Get the word out with invitations.

Cut out the invitation below, write in your event information, and then make copies to hand out. A reproducible poster can also be found in this kit.

 HarperCollins *Children's Books*

www.harpercollinschildrens.com

You're invited to a **B.Y.O.B.*** event in honor of the publication of the new picture book

NOT A BOX.

Please join us as we celebrate imagination, wonder, and creativity.

AT:

ON:

* **Bring Your Own Box**, of course!

Come with a plain cardboard box of any size to transform at this event.

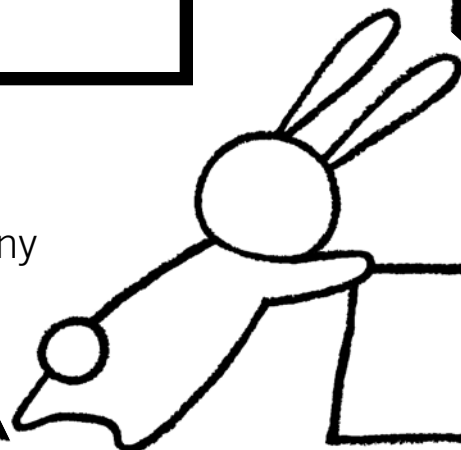

Hosting Your B.Y.O.B Event

A B.Y.O.B. event is as simple as a cardboard box that hasn't been doodled on yet. Below are some great ideas for getting your event started. Be creative! When working with the imagination, anything goes.

The box is essential! What's a Bring Your Own Box event without, well, a box? Remind your customers that they should bring a plain cardboard box on the day of the event. Be sure to have some extras on hand as well. Any size will do.

A box can be anything! After reading **NOT A BOX** with your guests, ask them how they want to decorate their boxes. Encourage them to let their imaginations run away with them, and remind them that their boxes can be anything they want. Make a list of box-decorating ideas on a large notepad so they can get started making their dreams come to life.

Supplies and demand! While this is a minimalist event (nothing fancy necessary), you'll need plenty of supplies on hand for box decorating. We suggest scissors, markers, crayons (especially red), construction paper, glue sticks, and any other arts-and-crafts supplies you have.

There's plenty more to do! In the following pages you'll find plenty of activities to keep your event in full gear. Be sure to make copies of the reproducible activities so that there's enough to go around.

Don't forget snacks! Imagining can make a kid hungry! Be sure to have special **NOT A BOX** snacks at your event to keep everyone's imaginations in full gear. Everyone's favorite boxy snacks: juice boxes and animal-cracker boxes.

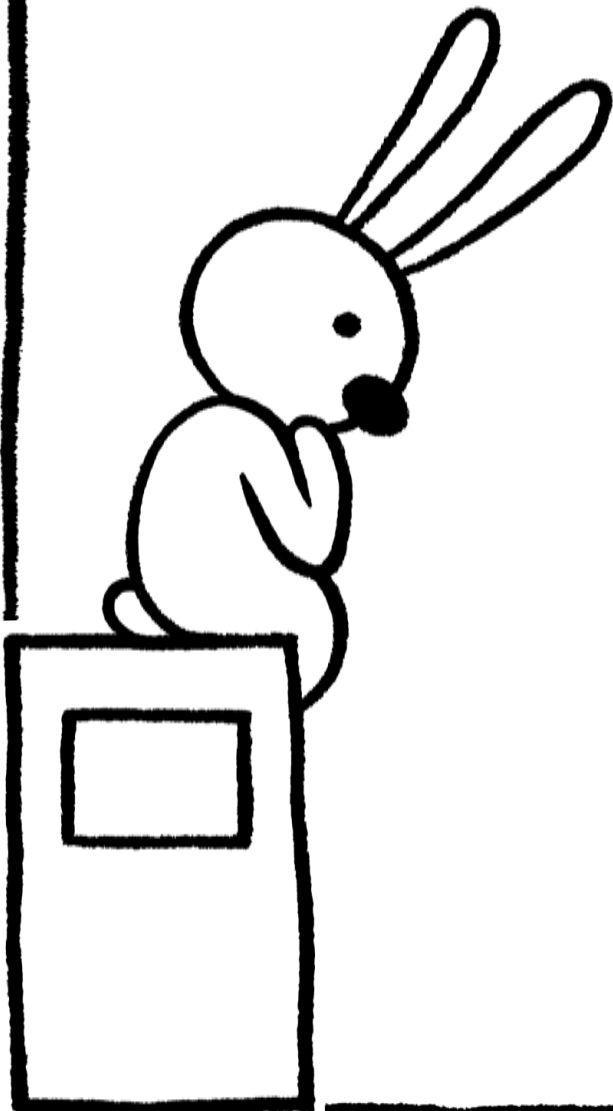

It's NOT A BOX!

Below are images of the bunny and his box. But his box can be anything! Use a crayon, marker, or pencil to draw in how you see the box.

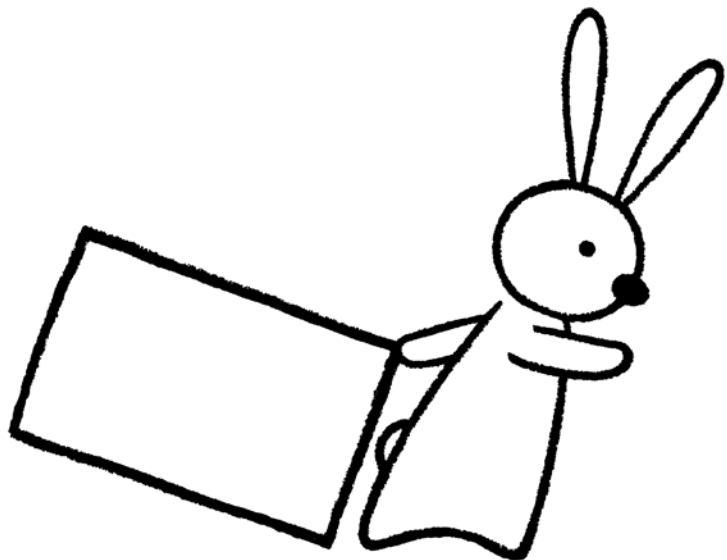
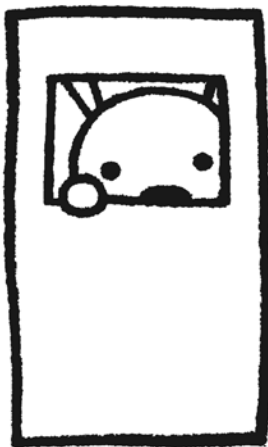
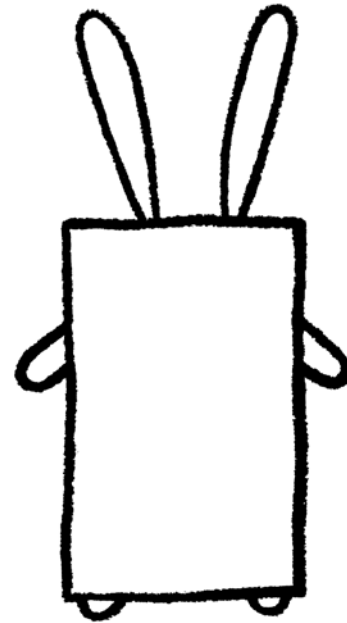
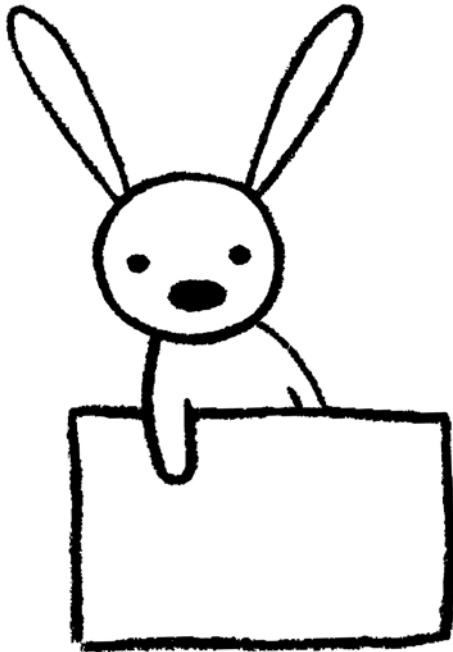

NOT A BOX Matching!

Can you match the drawings to what the bunny imagines his box to be?

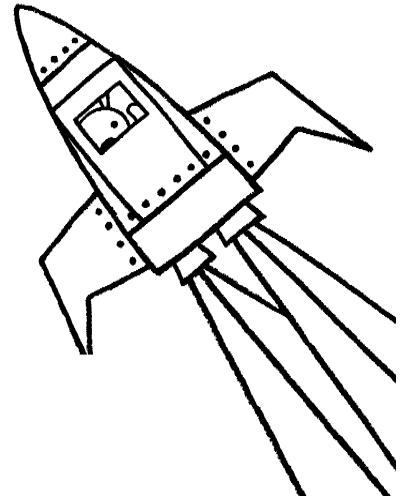
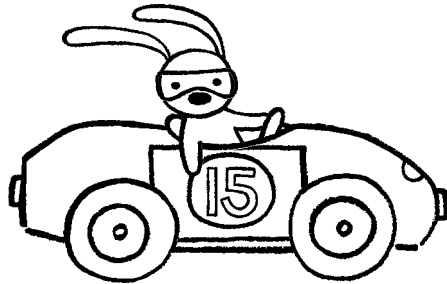
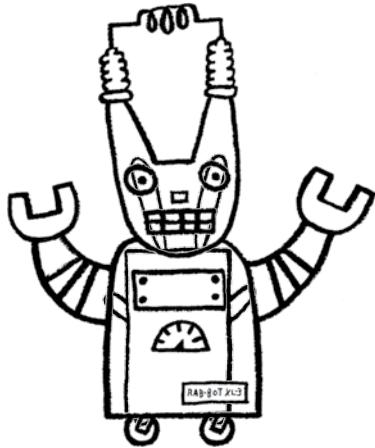

Burning Building

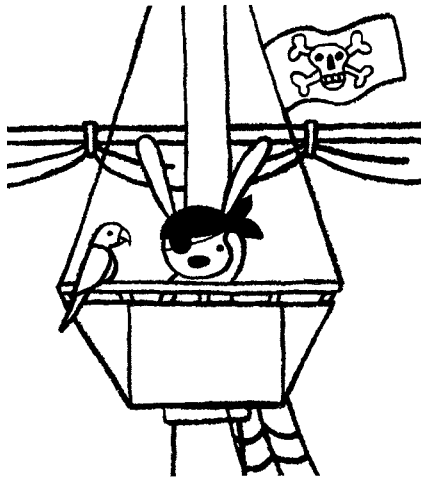

Race Car

Mountain

Tugboat

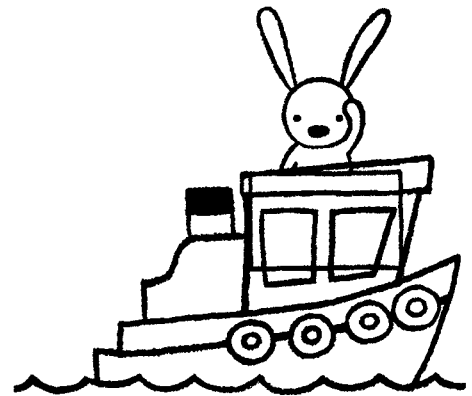

Pirate Ship

Rocket

Robot

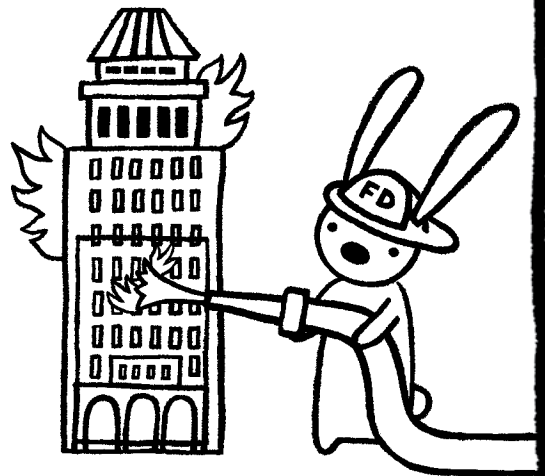
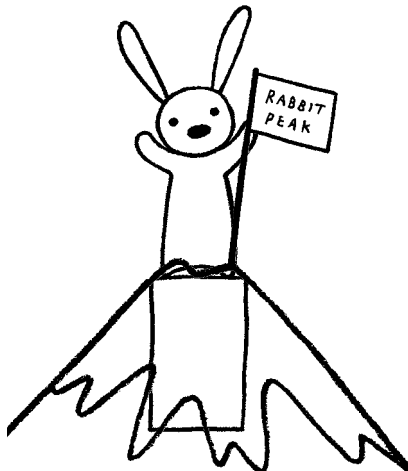

NOT a Coloring Sheet!

Use crayons and markers to add vibrant color to this picture from **NOT A BOX**.

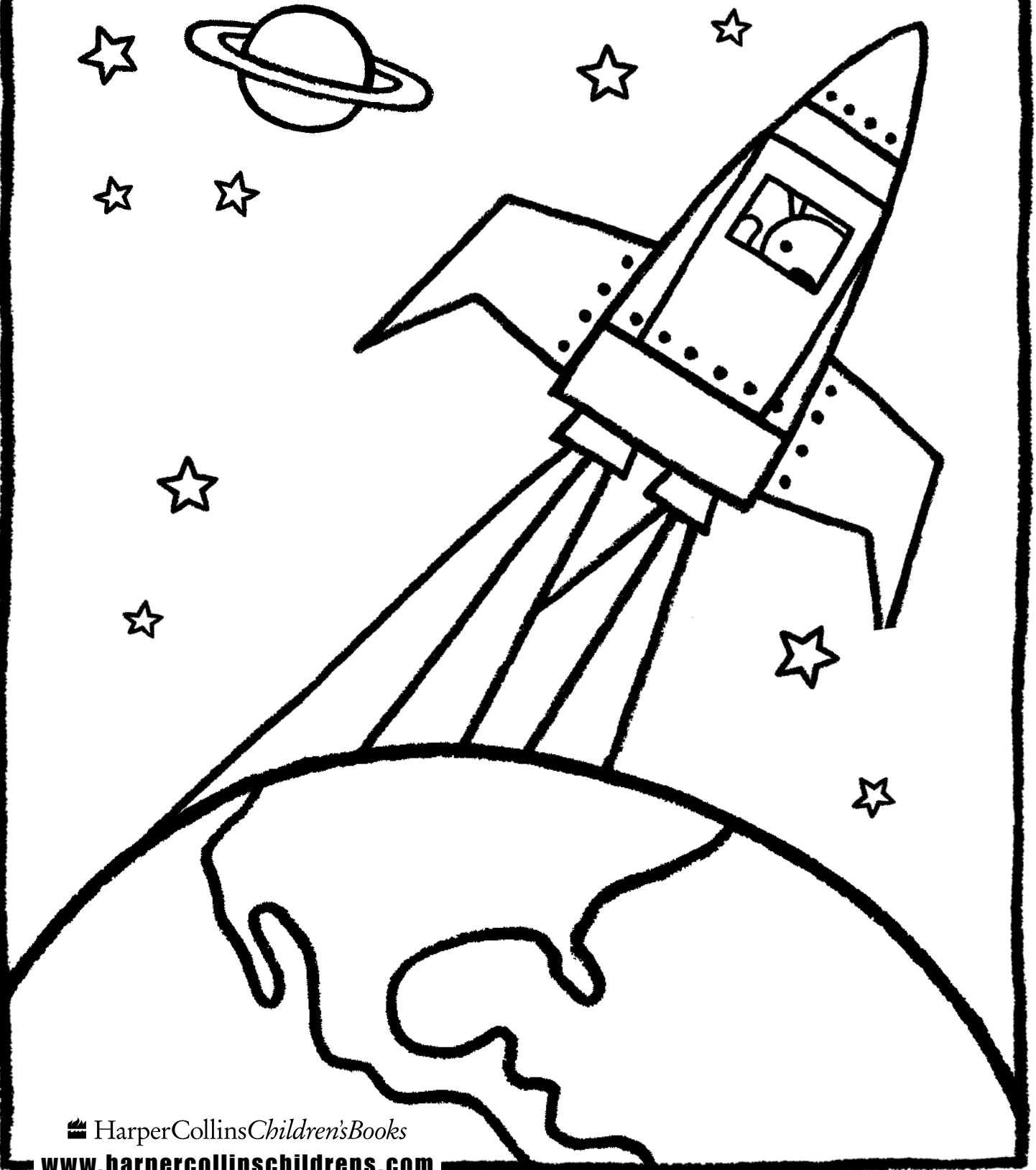

Make Your Own Not-a-Box!

Use two copies of the template and instructions on this page to make your own not-a-box, then decorate it however you like!

(Activity Coordinator: be sure make two copies of this page for each participant.)

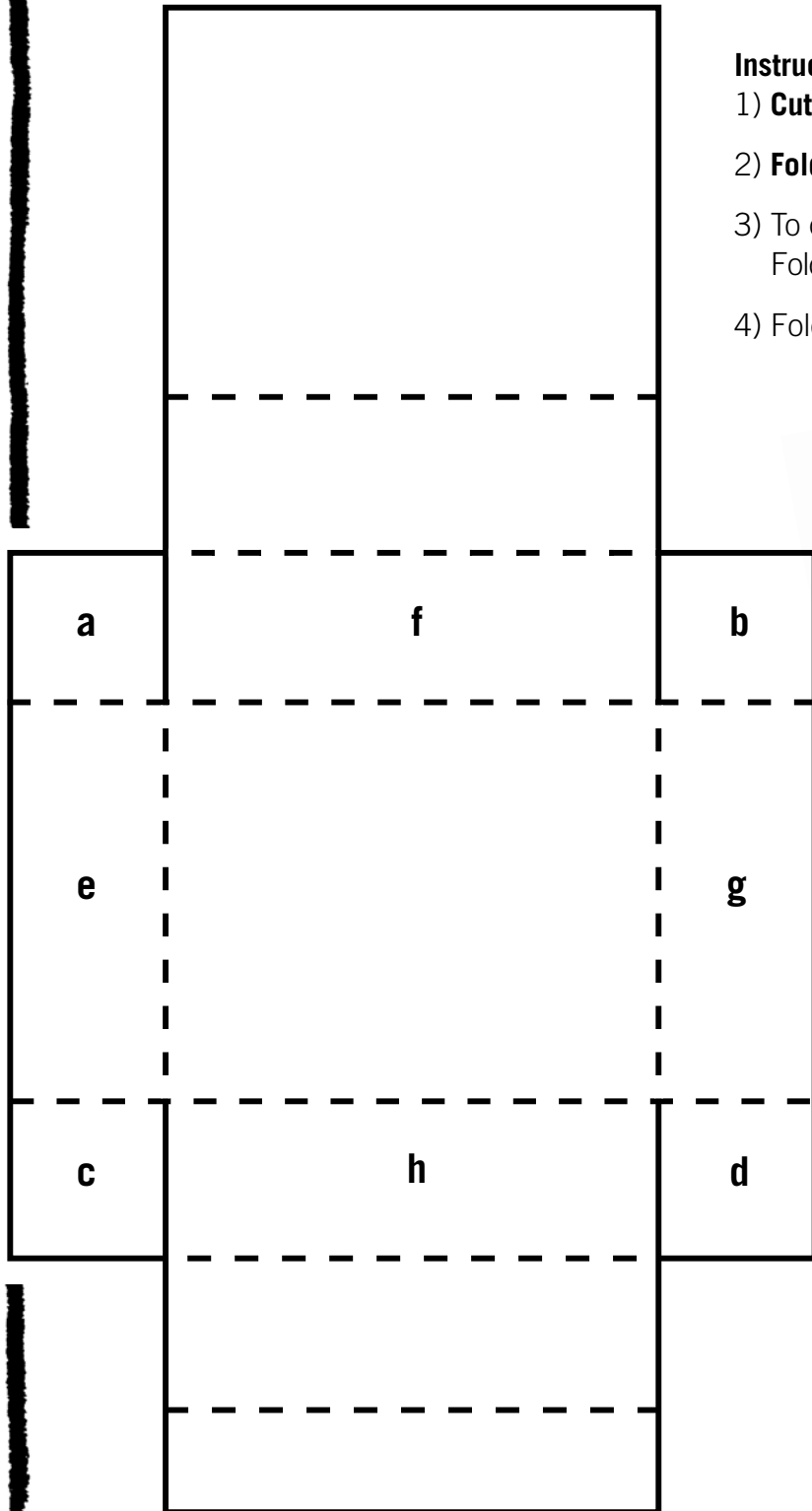

Instructions (requires adult assistance):

- 1) **Cut** along the solid lines.
- 2) **Fold** along dotted lines.
- 3) To create the bottom of the box:
Fold up the four corner flaps (a, b, c, d).
- 4) Fold in the side pieces (e, f, g, h).

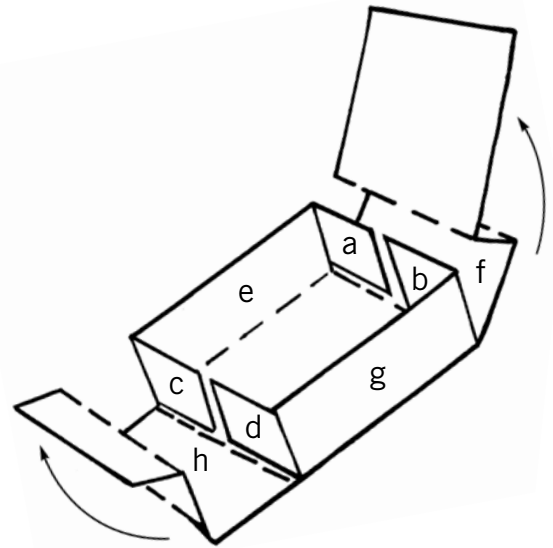

- 5) Fold the shorter side up and over the sides of your box, tucking the crease down into the fold at the bottom of the box.
- 6) Fold the longer side in the same way so that the last flap becomes the bottom of the box.
- 7) Using the second copy of the template, repeat steps 1 through 6 for the top of the box.
- 8) Decorate your Not-a-Box!

 HarperCollins *Children's Books*

www.harpercollinschildrens.com

**You're invited to a B.Y.O.B.*
event in honor of the publication
of the new picture book
NOT A BOX**

AT:

ON:

**Please join us as we celebrate
imagination, wonder, and creativity.**

***Bring Your
Own Box**, of course!
Come with a plain
cardboard box of
any size to transform
at this event.

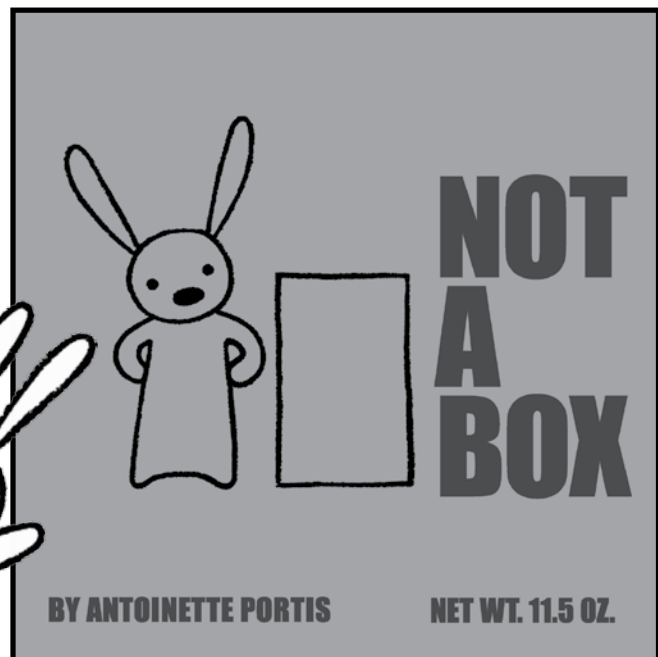
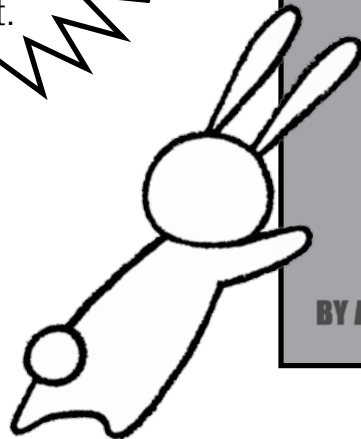

 HarperCollins *Children's Books*

www.harpercollinschildrens.com

HELLO 

My name is:

HELLO 

My name is:

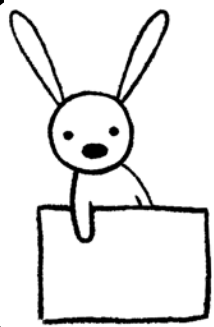
 **HELLO**

My name is:

 **HELLO**

My name is:

HELLO 

My name is:

HELLO 

My name is:

HELLO 

My name is:

HELLO 

My name is:

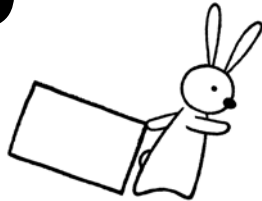
HELLO 

My Name is:

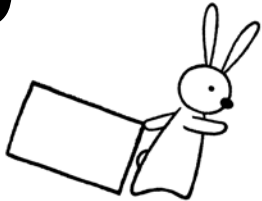
HELLO 

My name is: